

N560 series H/W Installation Guide

NexComm Systems, Inc.

Tel: +82-31-781-1862, Fax: +82-31-781-1863

E-mail: support@nexcomm.co.kr

Copyright

Copyright © 2007 NexComm Systems, Inc. All Rights Reserved.

This document contains information that is the property of NexComm Systems, Inc.

All or part of this document may not be copied, reproduced, reduced to any electronic medium or machine readable form, or otherwise duplicated, and information herein may not be used, disseminated or otherwise disclosed, except with the prior written consent of NexComm Systems, Inc.

Contact

NexComm Systems, Inc.

B-409, Bundang Techno-Park,
255 Yatap-Road, Bundang-Ku, Sungnam-City, Kyunggi-Do,
463-760, Korea
Tel. : +82-31-781-1862
Fax : +82-31-781-1863
E-mail : support@nexcomm.co.kr
Homepage : <http://www.nexcomm.co.kr>

Change Histroy

Version	Date	Effective H/W	Description
Rev 1.0	August 24th, 2010	H/W versions later than 0	Initial version
Rev 1.1	May 6th, 2013	H/W version later than 1.9.0	Changes of MAX Rate

Contents

Contents.....	4
1 Introduction	6
1.1 N560 series is..	6
1.2 Rules of Naming Models	6
1.3 List of the Models of N560 series	6
1.4 N560 series Appearance.....	7
2 Front / Rear Panel Features.....	8
2.1 Power Connector, Power Status LED and Reset Button.....	8
2.1.1 Type of Power Supply.....	8
2.1.2 Power Status LED	8
2.1.3 Reset Button.....	8
2.2 Console Part	9
2.3 SFP Port Part (100BASE-FX).....	9
2.3.1 Connector Part.....	9
2.3.2 100BASE-FX Status LEDs.....	10
2.4 LAN Port Part (10/100BASE-T).....	10
2.5 2BASE-TL Port.....	11
2.5.1 Connector Part.....	11
2.5.2 2BASE-TL PME Status LEDs	12
3 Installing N560 series.....	13
3.1 Checking in the Box.....	13
3.2 Connecting Power to N560 series	14
3.2.1 Connecting 5V DC Power into N560 series	14
3.2.2 Grounding N560 series	15
3.3 Connecting LAN Port to Other Network Devices.....	15
3.4 Connecting 100BASE-FX Port	16
3.5 Connecting 2BASE-TL Port.....	16
3.5.1 Connecting 2BASE-TL Port	16
3.5.2 2BASE-TL Synchronization	17
3.6 Connecting Console Port.....	17
4 Verifying that N560 series is Operational.....	18
4.1 Checking the Status of Power Connection.....	18
4.2 Checking the Status of LAN Port Connection.....	18

- 4.3 Checking 100BASE-FX connections 18**
- 4.4 Checking 2BASE-TL Connection..... 18**
- 5 Configuring N560 series through Console Connection 19**
- Troubleshooting N560 series 20**
- 6 Specification 22**
 - 6.1 Mechanical & Power Requirement 22**
 - 6.2 Network Interface 22**
 - 6.3 LAN Protocols 22**
 - 6.4 Management Interface 22**
 - 6.5 VLAN Support 23**
 - 6.6 QoS Support 23**
 - 6.7 Production & Regulatory 23**
 - 6.8 Environment 23**
 - A.1 Safety Information Warnings..... 24**
 - A.2 Symbols..... 24**
- APPENDIX B. Technical Assistance 25**
 - B.1 NexComm Systems' Technical Support..... 25**
 - B.2 Repair and Return Address 25**

1 Introduction

This document provides the procedures for installing the NexComm Systems' N560 series.

1.1 N560 series is..

N560 series, 2BASE-TL EFM EDD (Ethernet Demarcation Device) with two 100BASE-FX SFP ports, extends the reach of Ethernet services using bonded copper pairs and fiber optic cables. Designed with standard-based EFM technology (2BASE-TL), N560 series cost-effectively allows service providers and enterprises to deliver Ethernet services with symmetrical bandwidth at rates up to 60 Mbps via copper and 100 Mbps via fiber. The delivery of Ethernet services with N560 series can be made quickly by using existing copper plant.

1.2 Rules of Naming Models

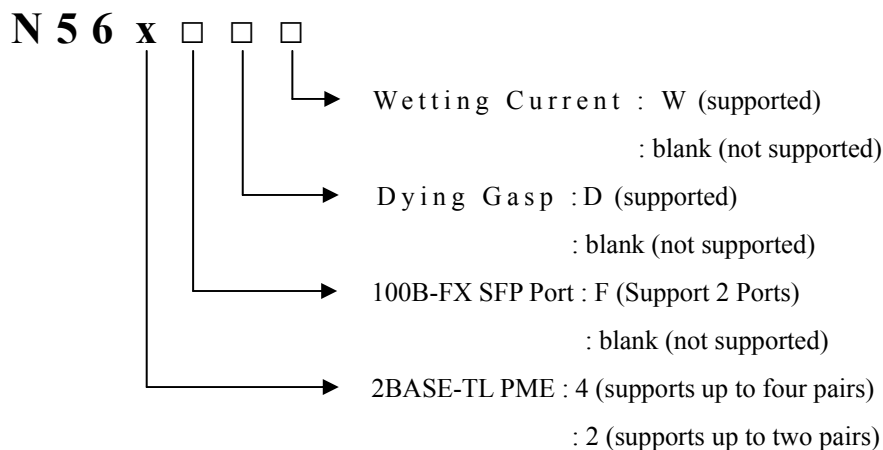

1.3 List of the Models of N560 series

[Table 1-1](#) lists the models of N560 series. For convenience of calling N560 series in certain groups, for example, with or without SFP ports, the convention of referring is given in [Table 1-1](#).

NOTE: In addition to [Table 1-1](#), N560 series can be classified according to its 2BASE-TL features. For instance, “ N564F / N564 “ may refer the group of models which have four 2BASE-TL PMEs. Similarly, “ N562F / N562 ” may have two.

Conventions		Model	Options	
100B-FX SFP	2BASE-TL PME Features		Dying Gasp	Wetting Current
N56xF (supported)	unsupported	N560F		
	2 pairs (p0, p3)	N562F		
	4 pairs (p0, p1, p2, p3)	N564F		

N56x	2 pairs (p0, p3)	N562		
(unsupported)	4 pairs (p0, p1, p2, p3)	N564		

< Table 1-1 > Models of N560 series

1.4 N560 series Appearance

Figure 1-1 shows exterior views of N560 series. Note that the appearances of N56xF and N56x are identical.



< Figure 1-1 > N560 series Front and Rear View

2 Front / Rear Panel Features

Figure 2-1 shows the front panels of N560 series. In addition, it describes each part's name.

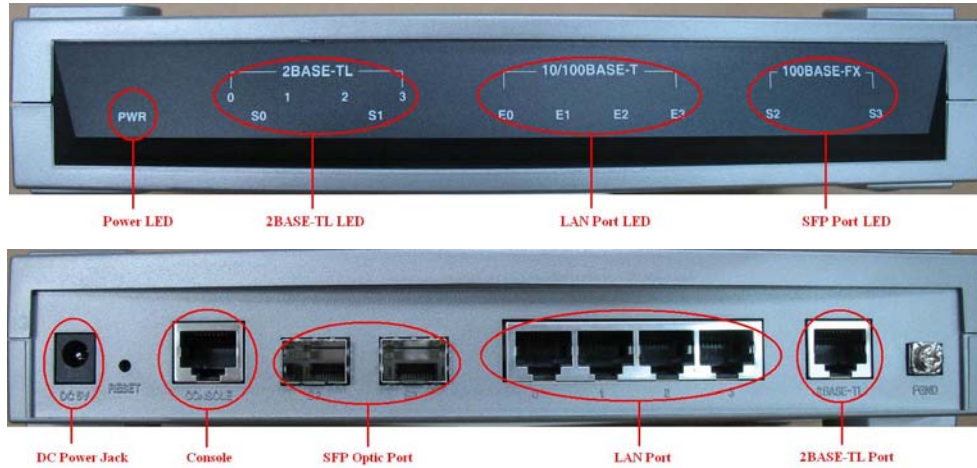

< Figure 2-1 > N560 series Front LEDs and Rear Ports

2.1 Power Connector, Power Status LED and Reset Button

2.1.1 Type of Power Supply

N560 series utilizes DC power. Connecting +100 ~ +250V AC to the connector of DC Adaptor which supplies 5V DC 3A by a power cord enables it to boot.

2.1.2 Power Status LED

This LED shows the status of power supply. [Table 2-1](#) summarizes the indication of the LED.

LED		POWER STATUS
GREEN	ON	Normal
	OFF	Power not being connected or abnormal operation of power circuit
YELLOW	ON	DC Adaptor Power Supply Abnormal(N5xx□D□ model only)
	OFF	DC Adaptor Power Supply Normal

< Table 2-1 > Indication of Power Status LED

2.1.3 Reset Button

This is a button to reset the system. With a pointed tool, such as a ball-pen, user may reach to the button. The system may reset, once a user clicks the button. Added to this, if a user keeps pressing the button until all the 2BASE-TL LEDs blinks five times, the system restores to the manufacturing configuration.

Operation on Reset button	Result
Clicking	System reset
Pressing Until 2BASE-TL Blinks 5 Times	System reset as factory default

< Table 2 - 2 > Function of Reset Button

2.2 Console Part

For connecting to a maintenance terminal (for example, PC), N560 series' RS-232 interface provides a RJ-45 female connector.

Figure 2-2 shows the pin assignments for the console port.

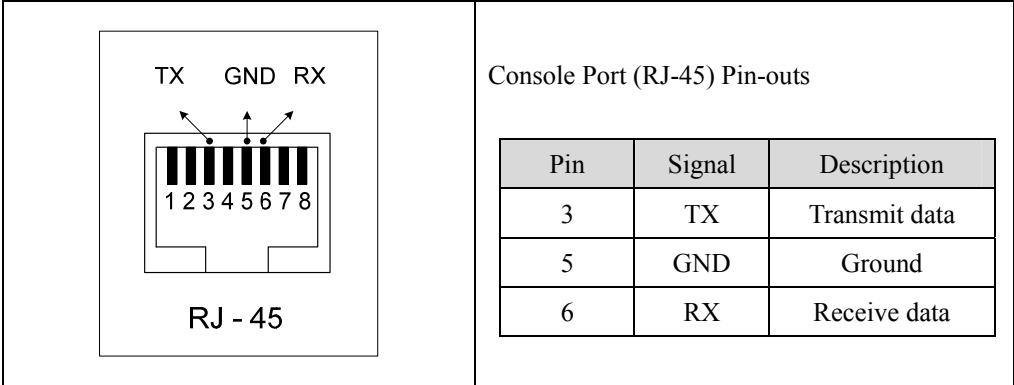

< Figure 2-2 > Pin Assignments for the Console Port

2.3 SFP Port Part (100BASE-FX)

2.3.1 Connector Part

N56xF have 100BASE-FX SFP Module interface provided with an LC type Fiber Optic connector.

Figure 2-3 shows the pin assignments for the SFP port.

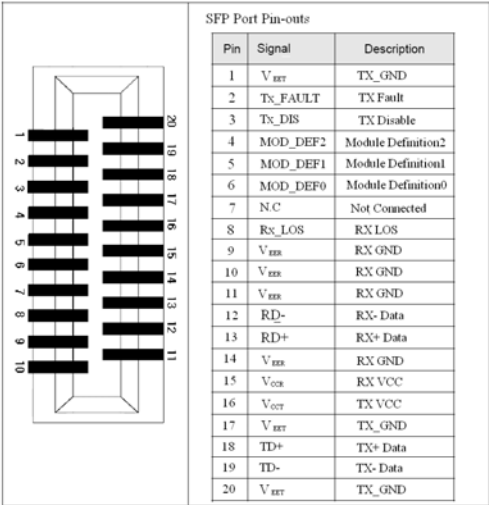

< Figure 2-3 > Pin Assignment for SFP Port Connector

2.3.2 100BASE-FX Status LEDs

For each 100BASE-FX, N56xF has LEDs showing the status of the Port.

Table 2-3 describes the LED's function.

LED		LINK STATUS / ACTIVITY
GREEN	ON	Fiber Optic port connected to the media
	OFF	Fiber Optic port disconnected to the media
	BLINK	RX data is being received
YELLOW	ON	-
	OFF	No TX data being transmitted
	BLINK	TX data is being transmitted

< Table 2-3 > Indication of 100BASE-FX LEDs

2.4 LAN Port Part (10/100BASE-T)

N560 series connects to a network device, such as Ethernet switch, through its 10/100 Mbps Ethernet ports. These ports of N560 series provide RJ-45 female connectors, so a user can use UTP cable with two RJ-45 jacks for the connection.

In addition, each Ethernet port has 2 LEDs so that a user can be aware of the Ethernet ports connectivity. One is for link status and RX status, the other for TX status.

Table 2-4 summarizes this.

LED State		Description
GREEN	OFF	LAN port disconnected to the media
	ON	LAN port connected to the media
	Blinking	LAN port connected to the media and RX data is being received
YELLOW	OFF	No TX data being transmitted
	Blinking	TX Data is being transmitted

< Table 2-4 > Indication of LAN Port Status LEDs

The LAN port supports 10/100Mbps speed on the UTP cable at a distance of up to 100 meters or less. Figure 2-4 lists the pin-outs for the LAN port connector (labeled "10/100BASE-T").

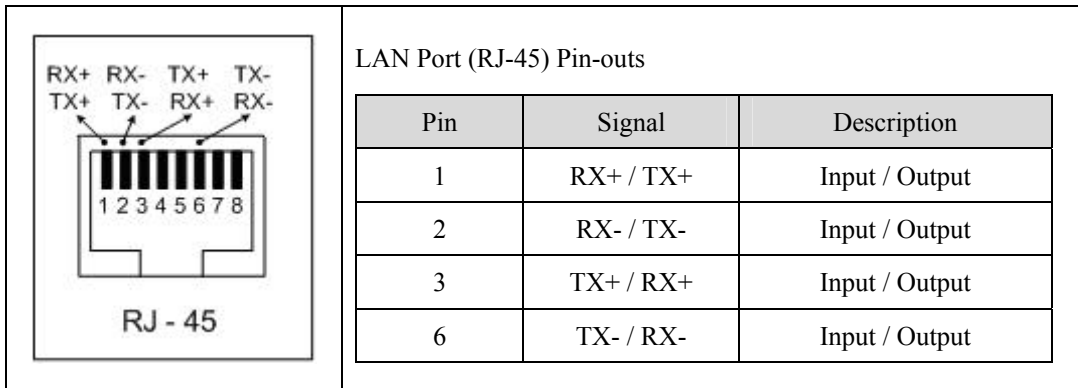

< Figure 2-4 > Pin Assignment for LAN Port Connector

2.5 2BASE-TL Port

2.5.1 Connector Part

N560 series has 2BASE-TL interface provided with an RJ-45 connector. For N564F / N564, 4 pairs of telephone lines can be bonded to support 2BASE-TL communication. For N562F / N562, 2 pairs can be used.

Table 2-5 lists this.

Models	Available Telephone Line Pairs (available PME)
N564F / N564	4 pairs (p0, p1, p2, p3)
N562F / N562	2 pairs (p0, p3)

< Table 2-5 > Available Telephone Line Pairs for Each Model of N560 series

Note that each PME uses different pins in the RJ-45 connector:

- p0 uses 4th and 5th pin of the RJ-45 connector
- p1 uses 7st and 8nd pin of the RJ-45 connector
- p2 uses 3rd and 6th pin of the RJ-45 connector
- p3 uses 1th and 2th pin of the RJ-45 connector

Also, N564F / N564 and N562F / N562 support Dual Interface Over DSL.

Table 2-6 lists this.

Models	Dual Interface Over DSL Ports
N564F / N564	S0 port (p0, p1), S1 port(p2, p3)
N562F / N562	S0 port (p0), S1 port(p3)

< Table 2-6 > Available Dual Interface Over DSL for Each Model of N560 series

Figure 2-5 lists the pin-outs for the RJ-45 connector.

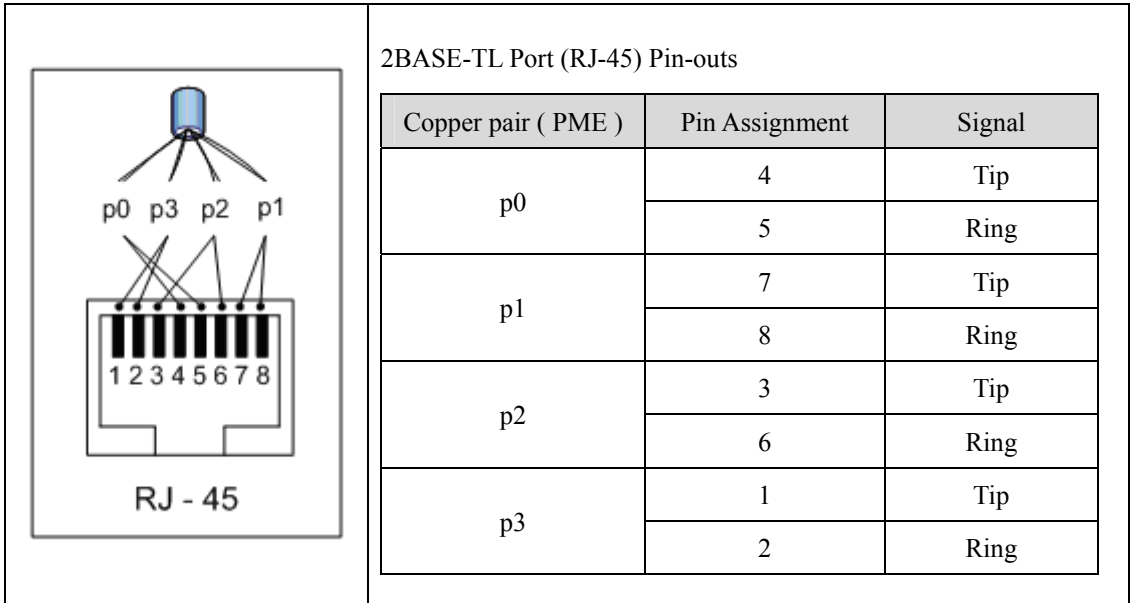

< Figure 2-5 > Pin Assignment for Each PMEs of 2BASE-TL Port

2.5.2 2BASE-TL PME Status LEDs



< Figure 2-6 > LEDs for Each PME

For each 2BASE-TL PME, N560 series has LEDs showing the status as Figure 2-6. Number attached nearby to the LED is the PME number.

Table 2-7 & 2-8 describes the LED’s function.

LED State		Description
GREEN (0~3)	Off	Data Link Down or Hand Shaking
	Slow Blinking	Training
	Fast Blinking	Synchronizing
	On	Data Link Up
YELLOW(S0)	Blinking	S0(Pair 0~3) binding Data is being tranceived

< Table 2-7 > Indication of 2BASE-TL LEDs(PME 4 Pair Binding Function)

LED State		Description
GREEN (0~3)	Off	Data Link Down or Hand Shaking
	Slow Blinking	Training
	Fast Blinking	Synchronizing
	On	Data Link Up
YELLOW(S0)	Blinking	S0 (Pair 0~1) binging data is being tranceived
YELLOW(S1)	Blinking	S1 (Pair 2~3) binging data is being tranceived

< Table 2-8 > Indication of 2BASE-TL LEDs(Dual Interface Over DSL)

3 Installing N560 series

This section guides how to install N560 series. User may be aware of the safety information in order to assure users' safety and N560 series' good performance. Attention required procedures will be accompanied with safety marks, one of the [Table A-1](#).

	<p>User should choose a proper place in which the equipment will operate.</p> <ul style="list-style-type: none"> ✓ The surrounding temperature must be in range of 0°C ~ 40°C and high humidity must be avoided. ✓ Basically, N560 series emits a considerable amount of heat. User should take care of the N560 series' ventilation. Do Not stack N560 series or block any slits on the N560 series' case. ✓ Avoid a direct ray of light and electrical interference. <p>Do not touch the pins of the connectors.</p> <p>Do not handle N560 series while you are wearing metallic accessories on hands.</p> <p>Do not disassemble N560 series. It may cause damage to the chips contained.</p> <p>Dealing with a problem, user may refer to section 6.</p>
---	---

3.1 Checking in the Box

Following items are needed, in addition to the main device, for the set-up of N560 series:

- DC adaptor (5V DC 3A)
- UTP cable with RJ-45 for LAN connection
- Console cable (RJ-45 male to DB-9 female)

Above items are described in [Figure 3-1](#).

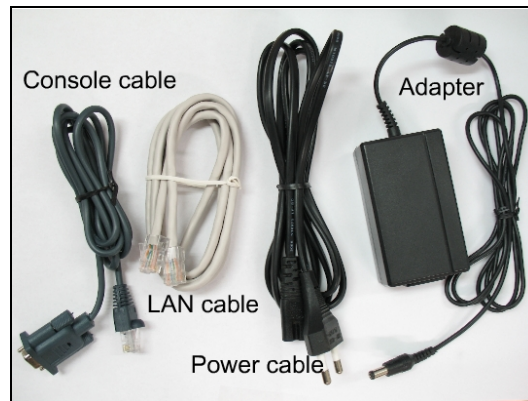

< Figure 3-1 > Cables in N560 series's Package

3.2 Connecting Power to N560 series

 <p>WARNING</p>	<p>User should be cautious when connecting powers.</p> <ul style="list-style-type: none"> ✓ AC power, which is plugged into the system directly or into the DC adaptor, has to be in appropriate range (+100 ~ +240V, 50-60 Hz). ✓ Plugs must not be handled with wet hands.
--	--



3.2.1 Connecting 5V DC Power into N560 series



< Figure 3-2 > N560 series Power Connection

- ① Connect one end of the power cable to the DC adaptor.
- ② Plug the other end of the power cable into the power terminal (+100 ~ +240V AC).
- ③ Plug the end of the AC/DC power adaptor into the port named "5V DC 3A" on the front panel of the N560 series.
- ④ Power LED on the front panel may turn on if the power supply is normal.

3.2.2 Grounding N560 series

	<p>Touching ports on the front panel or connecting cables may induce static electricity. In the extreme, this can damage the chipsets in the N560 series system. To prevent this effectively, user may wear a grounding wrist strap before installing or dealing with N560 series.</p>
	<p>In addition, grounding the system through the ground pin makes system more secure electrically. You may see this ground pin (with a symbol depicted here) on the rear panel (rightmost on N560 series). Wire this ground pin between earths' ground.</p>

3.3 Connecting LAN Port to Other Network Devices



< Figure 3-4 > LAN Port (10/100BASE-T) Connection

- ① Confirm if the UTP cable connector is a RJ-45 jack.
- ② Connect one end of the UTP cable to the network equipment such as a switch or hub.
- ③ Connect the other end of the UTP cable to one of the ports named "10/100BASE-T" on the front panel of the N560 series.

NOTE : The LAN port is auto-MDI/MDIX capable; you can use either straight-through or crossover cable to connect a network device (PC or Hub/Switch).

3.4 Connecting 100BASE-FX Port



< figure 3-4 > 100BASE-FX Port connection

- ① Insert SFP Module to the port named "100BASE-FX" on the front panel of the N56xF.
- ② Connect the assembled LC type Fiber Optic connector to SFP Module.

3.5 Connecting 2BASE-TL Port



< Figure 3-5 > 2BASE-TL Port Connection

3.5.1 Connecting 2BASE-TL Port

 <p>CAUTION</p>	<p>When making 2BASE-TL cable with telephone line pairs, be sure that telephone lines are clipped into the RJ-45 connector in the correct order.</p>
---	--

- ① To connect Lines to 2BASE-TL port in the equipment, four pairs of regular telephone lines preinstalled for the G.SHDSL.bis connection have to be clipped with a RJ-45 jack. Note that each pair of lines must be plugged in the correct combination of pins of RJ-45 jack (refer to [Figure 2-4](#)).
- ② Connect the assembled RJ-45 connector to the port named "2BASE-TL" on the front panel of the equipment.

3.5.2 2BASE-TL Synchronization

When two devices with 2BASE-TL port is configured as CO and RT (to configure the mode of 2BASE-TL PME, user may use the console port – refer to [section 5](#)), respectively, and connected with copper-pair line, they will go through a synchronization for a couple of minutes at most (at least, about a half minute; time taken for sync depends on the state of the line). The state of trying sync is called TRAINING, and the LED of the PME in this state may blink. If the devices synchronized successfully, the PME-number-tagged LEDs may be constantly turned ON.

3.6 Connecting Console Port



< Figure 3-6 > Console Cable Connected to N560 series

To configure the N560 series, the simplest way is to use a console connection between the equipment and PC. As described in [section 2.2](#), console cable has a DB-9 female connector which will be connected to the PC and a RJ-45 male connector which will be plugged in the equipment. In this section, only the cable plugging step is described. To log into the system, user may refer to [section 5](#).

- ① Connect the RJ-45 jack of the console cable to the port named "CONSOLE" on the front panel of the equipment.
- ② Connect the DB-9 female, the other end of the console cable, to the COM port of the PC.

4 Verifying that N560 series is Operational

The purpose of this section is to verify if the equipment is functioning normally after all installation process is done. User may step the following procedures. If the device turns out to be malfunctioning, user should refer to the troubleshoot section (section_6) in order to fix it.

4.1 Checking the Status of Power Connection

- ① Verify that the device is connected to an operational AC to DC power adaptor.
- ② Check if the device is powered on: power LED may be ON constantly.

4.2 Checking the Status of LAN Port Connection

- ① Verify that a CAT-5 UTP cable is connected from one of the device's 10/100 Mbps LAN ports to an operational network device.
- ② Verify that the LAN port's Green LED are ON, indicating that a connection has been established between the equipment and the other network device.
- ③ Verify that the LAN port's Green LED and Yellow LED are blinking when traffic is flowing into the port (traffic being received) or out through the port (traffic being transmitted), respectively.

4.3 Checking 100BASE-FX connections

- ① Verify that SFP Module & Fiber Optic lines are connected to a 100BASE-FX port.
- ② Verify that two devices connected with their 100BASE-FX link up.
- ③ If the S2 or S3 Green LED still doesn't turn ON, 100BASE-FX connection is not linked up.
Check SFP Module and port configuration.

4.4 Checking 2BASE-TL Connection

- ① Verify that telephone lines (copper-pair cable) are connected to a 2BASE-TL port.
- ② Verify that two devices connected with their 2BASE-TL PME's link up.
- ②-1 If a device configured as CO and another configured as RT are connected by copper-pair cable through their 2BASE-TL port they may "link up". Each PME's link-up state is indicated by its Green LED powered ON.
- ②-2 If the Green LEDs don't turn ON after an enough sync time, 2BASE-TL connection isn't linked up.

5 Configuring N560 series through Console Connection

- ① As described in [section 3.5](#), user may plug the console cable into both PC and the equipment.
- ② Configure the communication settings of the PC's terminal program, as below.

Baud rate: 38400 bps
 Data bit: 8
 No parity
 1 stop bit
 Hardware flow control set to off

- ③ If a user powers the equipment on, and if the console connection is correct, user may see booting messages through the terminal program. After the booting process, "Enter password" message will pop up. (If the booting process of the equipment is finished before console connection, user may miss the boot messages. In this case, simply input **ENTER** key into the terminal program and user may be able to see "Enter password" message)
- ④ User may type the password to log into the system. (Password is preliminarily set as "password"; user may change the password - refer to the CLI manual)
- ⑤ User may configure the system with the instruction set provided in the CLI manual.

NOTE: This *H/W install guide* includes 2BASE-TL port connection and verifying its function. Therefore, some basic 2BASE-TL port setting commands is provided here:

Operation on N560 series	Command input
Setting N560 series as CO mode	set devicetype co
Setting N560 series as RT mode	set devicetype rt
Setting N560 series as PME binding mode	set devicemode binding
Setting N560 series as Dual Interface Over DSL mode	set devicemode separate
Restarting N560 series as the changed mode	restart pme all

< Table 5-1 > Configuring Mode of 2BASE-TL Port

To apply the change in the mode, you should input the last command, "restart pme all". Due to this command, the PMEs will sync with the renewed configuration.

Troubleshooting N560 series

When you have problems with N560 series, this troubleshooting section can be referred to. If you have difficulty in fixing it or the trouble is beyond this document, you may request a Technical Assistance to our technical support team. (see [appendix B](#) for Technical Assistance)

[Table 5-2](#) provides troubleshooting procedures, and [Figure 5-1](#) describes status LEDs.

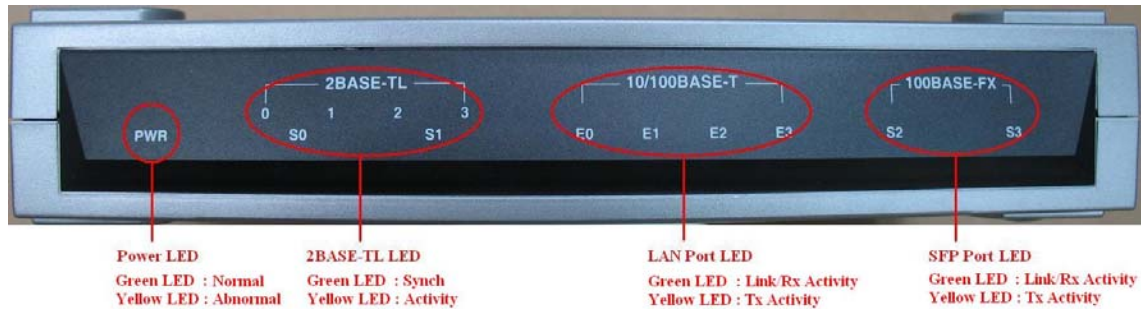

< Figure 5-1 > Description of Status LEDs

Condition	Solution
Power LED (OFF or Yellow)	①-1 Verify that the DC adaptor’s cable plug is connected to an operational power source (+100 ~ +240V AC). ①-2 Verify that that DC adaptor is operational
Console connection disable	① Verify that the console cable’s DB-9 connector and RJ-45 jack is plugged firmly. ② Verify that communication options are correctly set. (refer to section 5)
2BASE-TL Port’s LEDs OFF with no blinking	In normal operation (a pair of devices, one set as CO, the other set as RT), 2BASE-TL LED will be off if there is no copper pair connected to the port (or if a copper pair is connected at the port but is not terminated at an operational remote device) 1. Verify that the remote device is operational and the mode is set as different mode from the device itself. 2. Verify that copper pairs are wired correctly in the copper pair. (refer to Figure 2-4)
2BASE-TL Port’s LED blinking but not entering ON state	1. Verify that the line state is normal (state, such as distance). If the distance of the line is too long to sync, it may fail to link up.

LINK / RX LED (GREEN)	<p>In normal operation, the network LINK LED is on when a link is detected between the N560 and a remote device.</p> <ol style="list-style-type: none"> 1. Verify that the CAT-5 cable is connected properly to a 10/100Mbps port on an operational Ethernet device.
TX LED (YELLOW)	<p>In normal operation, the network RX LED, TX LED, or both blink when the device detects traffic on the Ethernet port.</p> <p>If the these LED is off and the Network LINK LED is on:</p> <ol style="list-style-type: none"> 1. Verify that there is Ethernet traffic on the network connection.
100BASE-FX Port's LEDs	<p>In normal operation, 100BASE-FX LED will be off if there is no Fiber Optic connected to the port (or if a Fiber Optic is connected at the port but is not connected at an operational remote device)</p> <ol style="list-style-type: none"> 1. Verify that the remote device is operational and the mode is set as different mode from the device itself. 2. Verify that Fiber Optic is wired correctly in the Fiber Optic cable. (refer to the)

< Table 5-2 > Troubleshooting Procedure

6 Specification

6.1 Mechanical & Power Requirement

- ✓ Dimension(mm): 238(W) X 182(D) X 47(H)
- ✓ Weight: 0.8 kg
- ✓ DC 5V 3.0A
- ✓ All Rear Access

6.2 Network Interface

- LAN
 - ✓ Four 10/100BASE-T Ports (RJ-45)
 - ✓ Auto MDI/MDIX
- Fiber Optic(N56xF only)
 - ✓ 100BASE-FX(IEEE802.3u)
 - ✓ 2 X SFP LC Type connectors
 - ✓ SFP MSA & SFF-8472 Specification
- WAN
 - ✓ ITU-T G.991.2.(2004)
 - ✓ 2BASE-TL, 64/65o encoding
 - ✓ EFM bonding (IEEE 802.3ah PAF)
 - ✓ Dual Interface Over DSL (IEEE 802.3-2004) (except N560F)
 - ✓ RJ-45 Connector
 - ✓ Max 22.8Mbps (5.7Mbps / Port)

6.3 LAN Protocols

- ✓ 802.1d Transparent Bridging
- ✓ Up to 8K MAC Address

6.4 Management Interface

- ✓ Console (RS-232, RJ-45)
- ✓ Web Browser(HTTP), SNMP, Telnet
- ✓ EFM (IEEE 802.3ah) OAM
- ✓ RCMP (Remote Control & Management Protocol)

6.5 VLAN Support

- ✓ Port-based VLAN
- ✓ Tag-based VLAN (802.1Q)
- ✓ Up to 256 VLANs
- ✓ Double Tagging (Q-in-Q)
- ✓ VLAN Trunk mode

6.6 QoS Support

- ✓ Ingress Rate control
- ✓ Egress Traffic Shaping
- ✓ Classification based on Port/802.1p/DSCP
- ✓ 4 Priority Queues
- ✓ Strict Priority
- ✓ Simple WFQ

6.7 Production & Regulatory

- ✓ ISO 9001 Quality Management
- ✓ ISO 14001 Environmental management
- ✓ CE Approval
- ✓ VCCI Approval

6.8 Environment



- ✓ Operating Temperature : 0°C ~ 50°C
- ✓ Extended Operating Temperature : -40°C ~ 65°C
- ✓ Storage Temperature : -40°C ~ 85°C
- ✓ Relative Humidity : 98%, non-condensing

APPENDIX A. Safety Information

A.1 Safety Information Warnings

- ✓ Install the equipment only as described in this document. Other manipulations may cause a problem to N560 series.
- ✓ Never install telephone wiring during a lightning storm.
- ✓ Never install telephone jacks in wet locations unless the jack is specifically designed for wet locations.
- ✓ Use caution when installing or modifying telephone lines.
- ✓ User may prepare a proper environment for installing N560 series as specified in the document. (temperature, humidity).

A.2 Symbols

Symbol	Description
 CAUTION	Please follow the documented procedures. Otherwise, the equipment is likely to be damaged or inoperative.
 WARNING	Take precaution against a electrical shock.
 ESD	The part of the equipment is to be Electro-Static Discharge-sensitive. Pay attention to the safety information and procedures.

APPENDIX B. Technical Assistance

During the hours from 0:00 AM to 11:00 AM (GMT), Monday through Friday, calls and e-mails will be answered directly by the NexComm Systems' Technical Support Team.

B.1 NexComm Systems' Technical Support

- NexComm Systems Technical Assistance Center phone number is:

82-31-781-1862

- E-mail access to the Technical Assistance Center is available at:

support@nexcomm.co.kr

B.2 Repair and Return Address

Before you return a product to NexComm Systems, you must obtain a Returned Materials Authorization (RMA) number from the NexComm Systems Technical Assistance Center.

The NexComm Systems repair and return address is:

B-409, Bundang Techno-Park,
255 Yatap-Road, Bundang-Ku, Sungnam-City, Kyunggi-Do,
463-760, Korea